

Обмерный план наружных стен

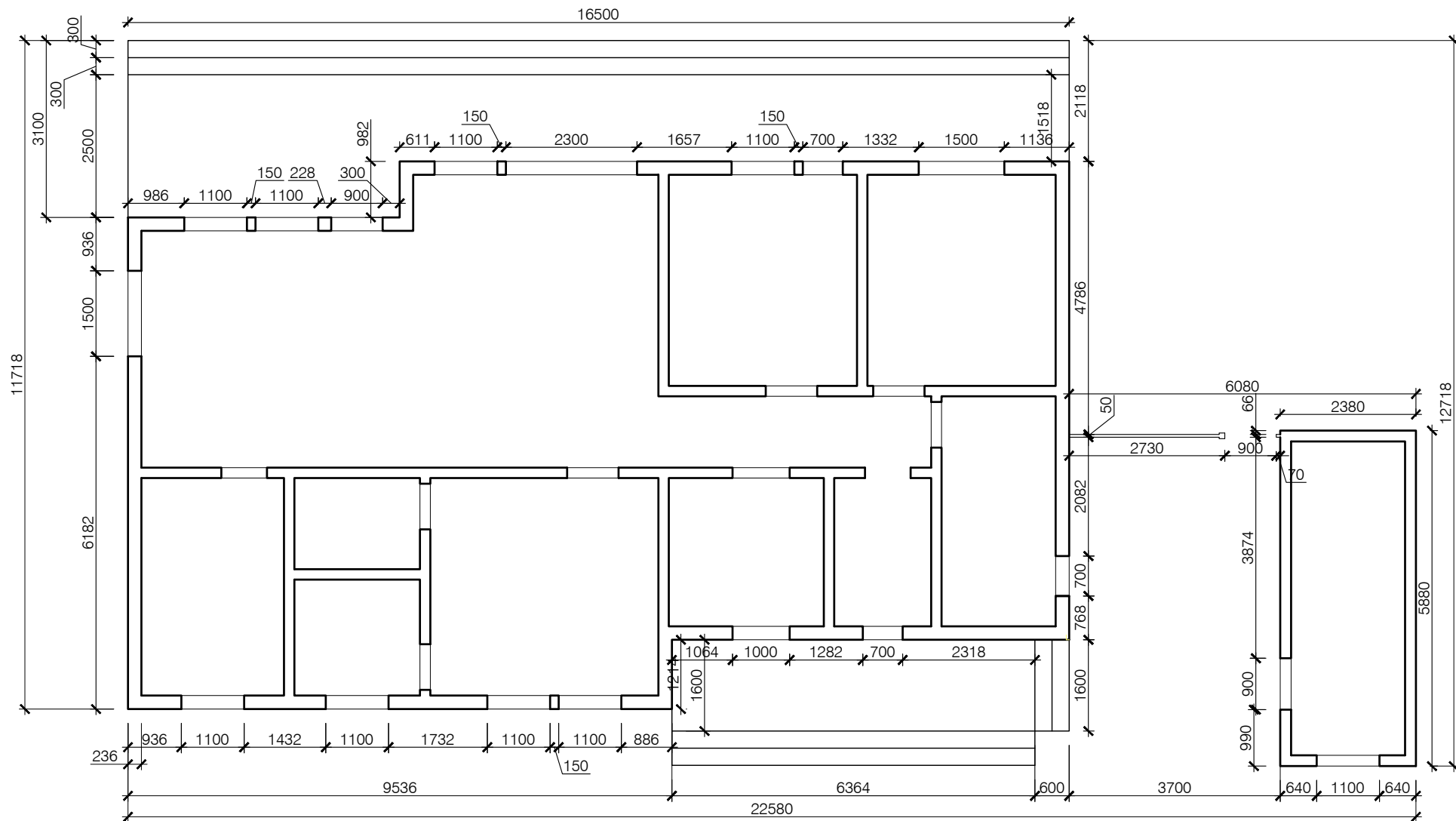

Обмерный план внутренних стен

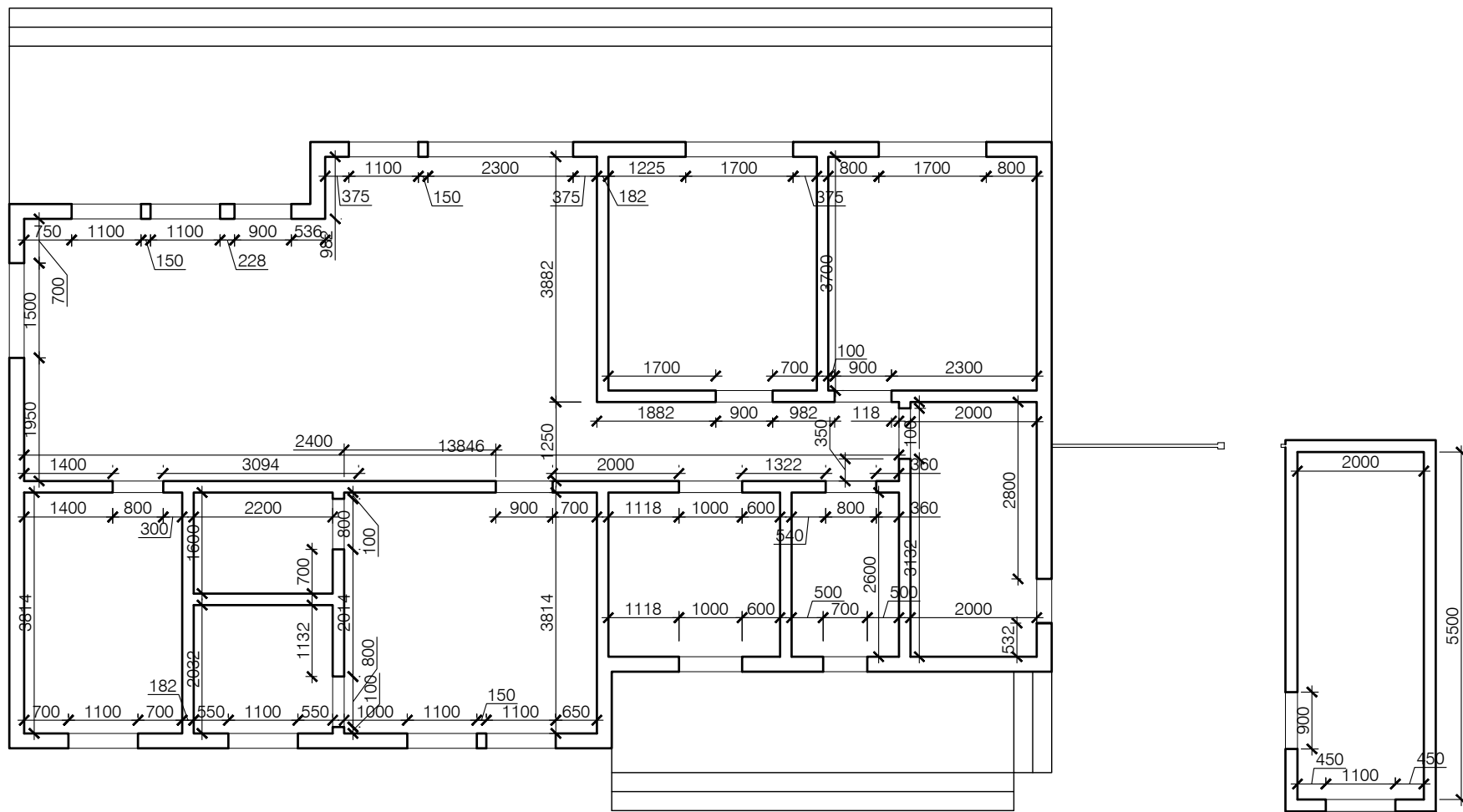

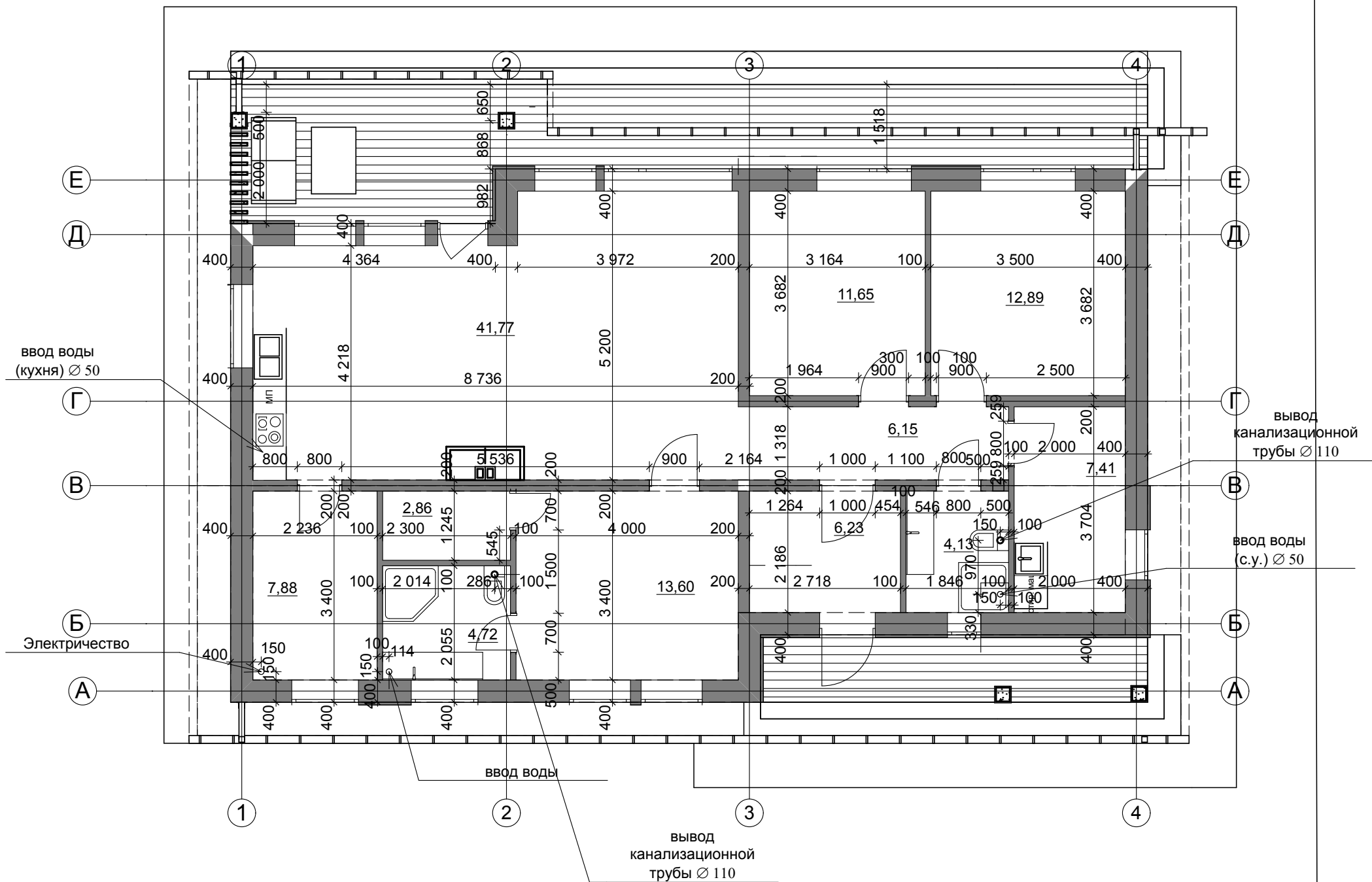

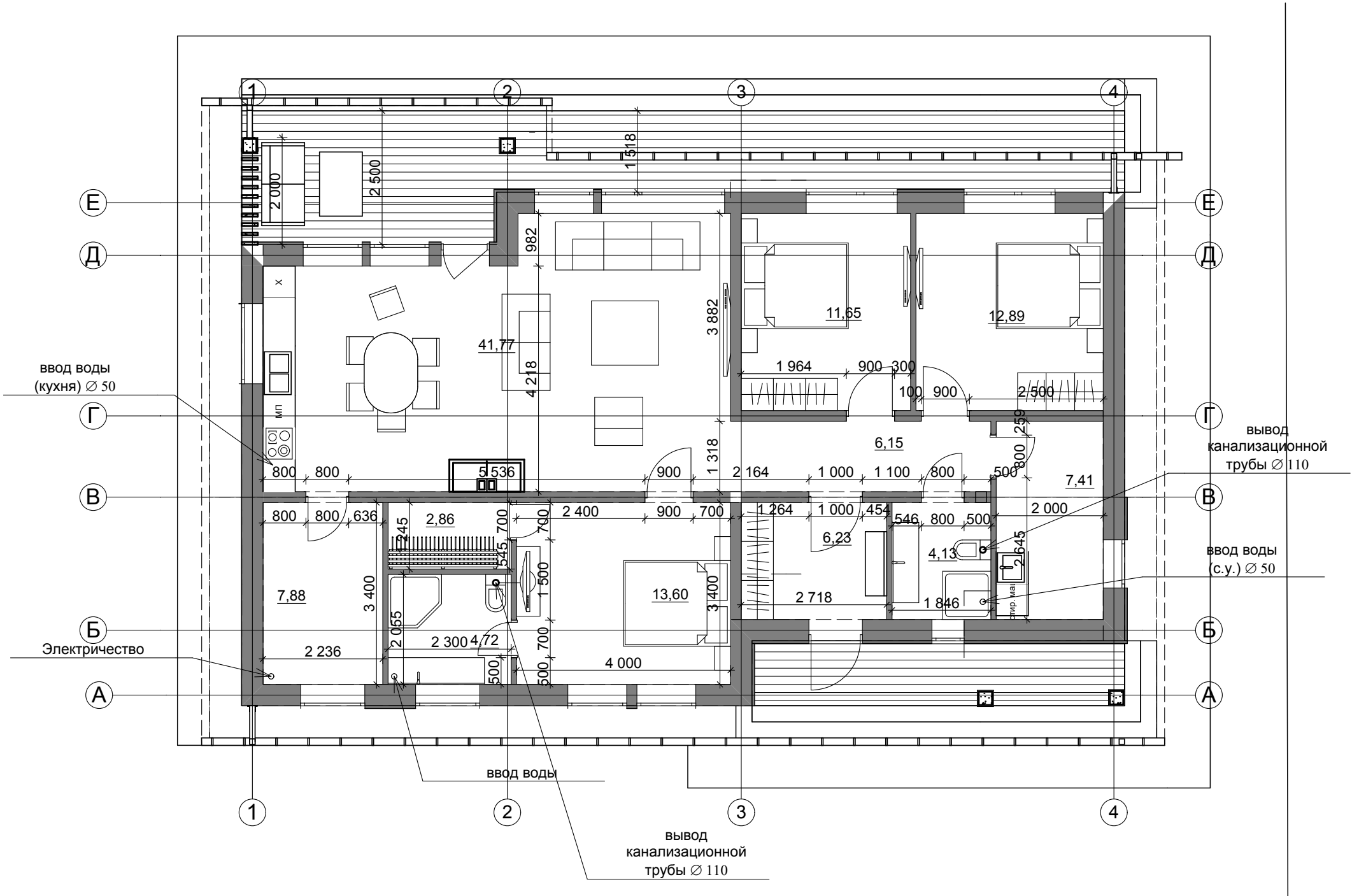

Узел 1
Опираие деревянных балок
чердачного перекрытия

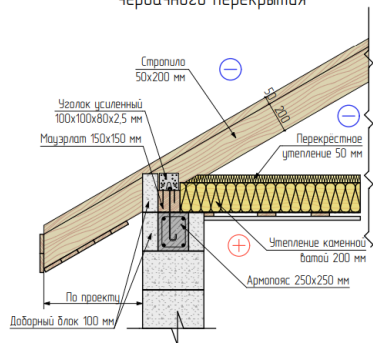

Разрез 2-2

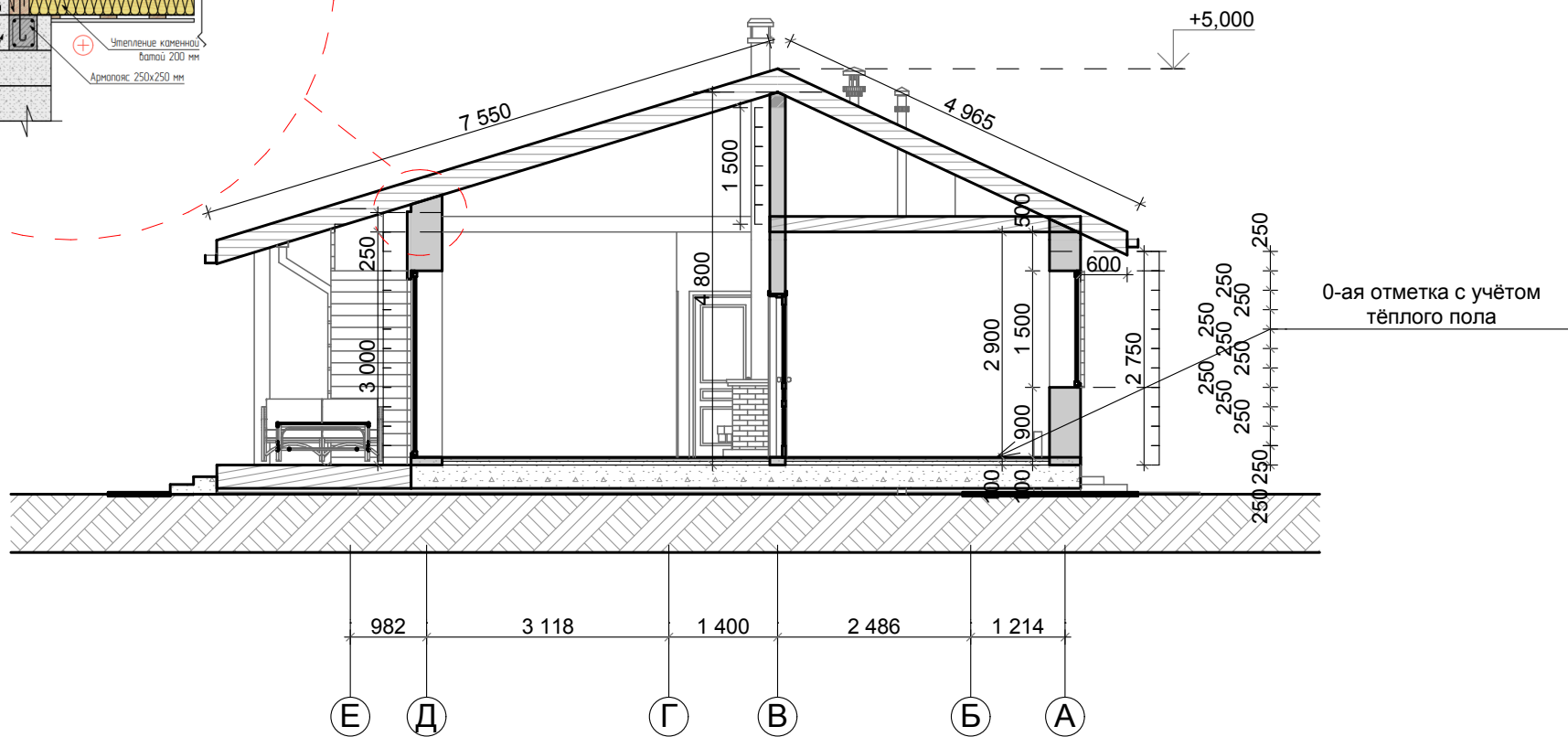

Разрез 6-6

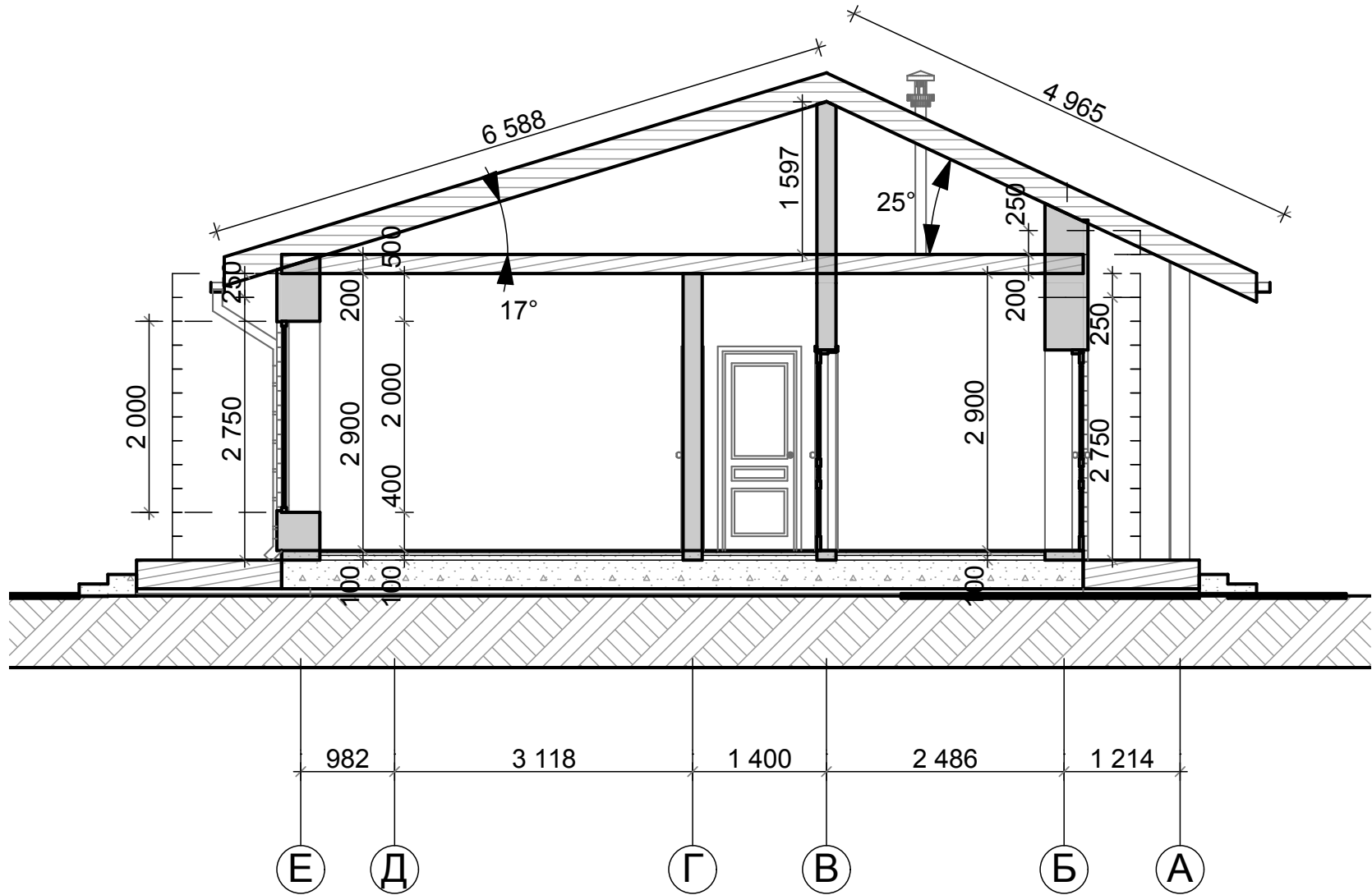

Узел 1
Опираие деревянных балок
чердачного перекрытия

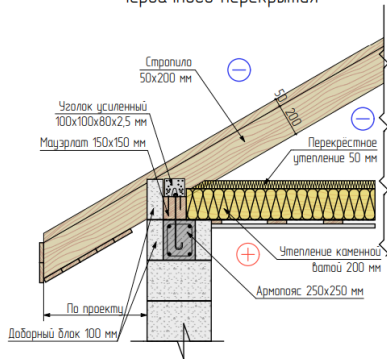

Разрез 2-2

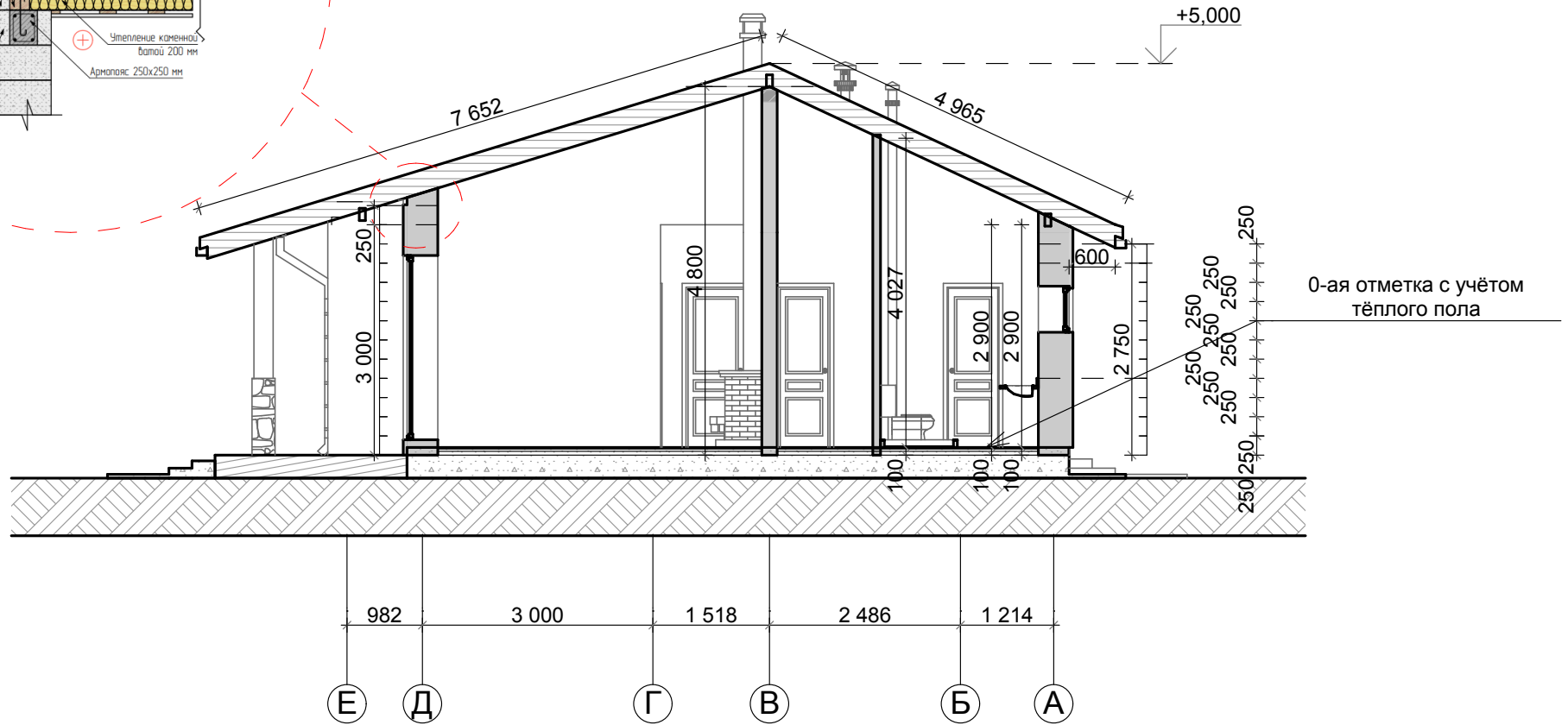

Разрез 6-6

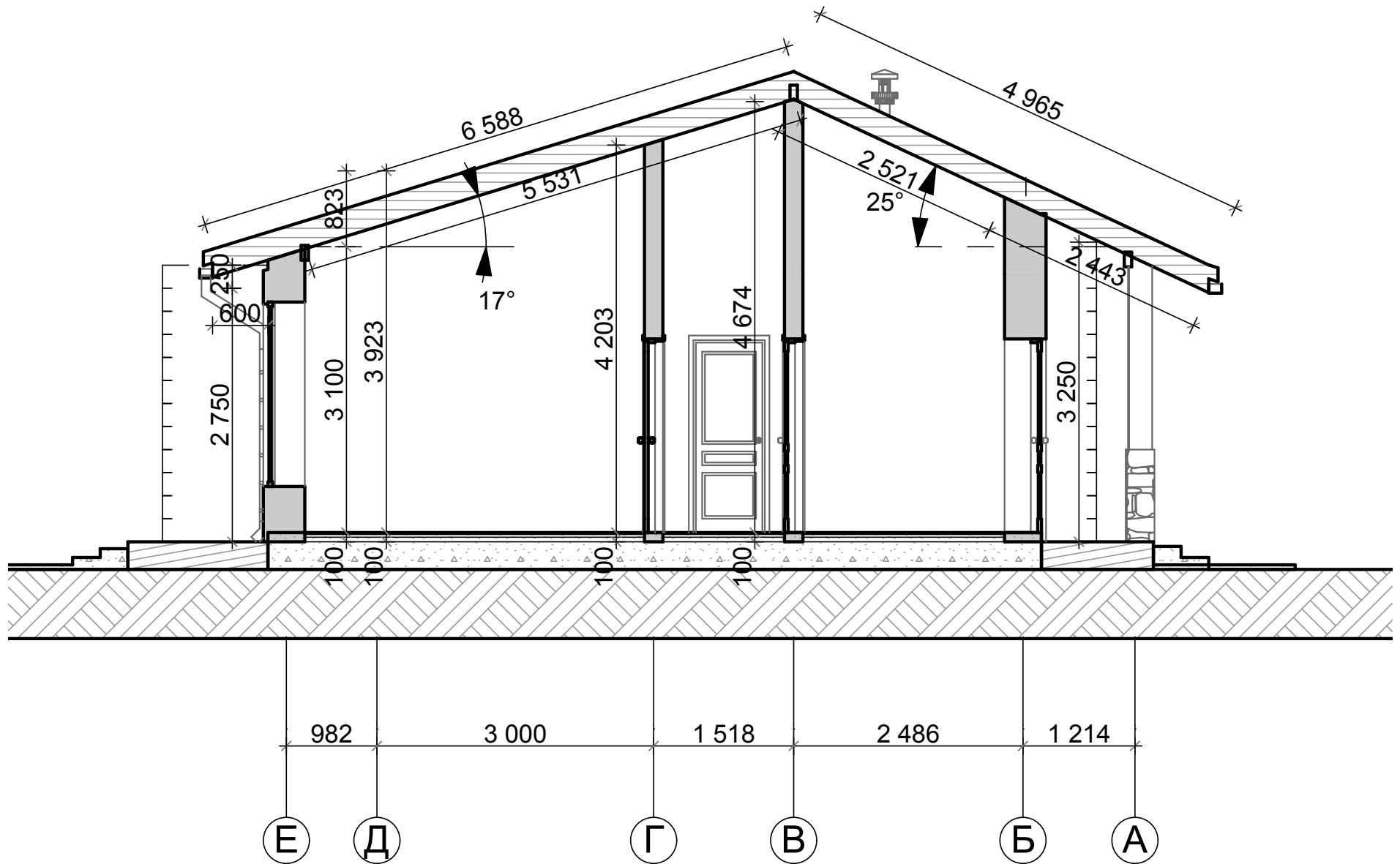

Фасад 1-4

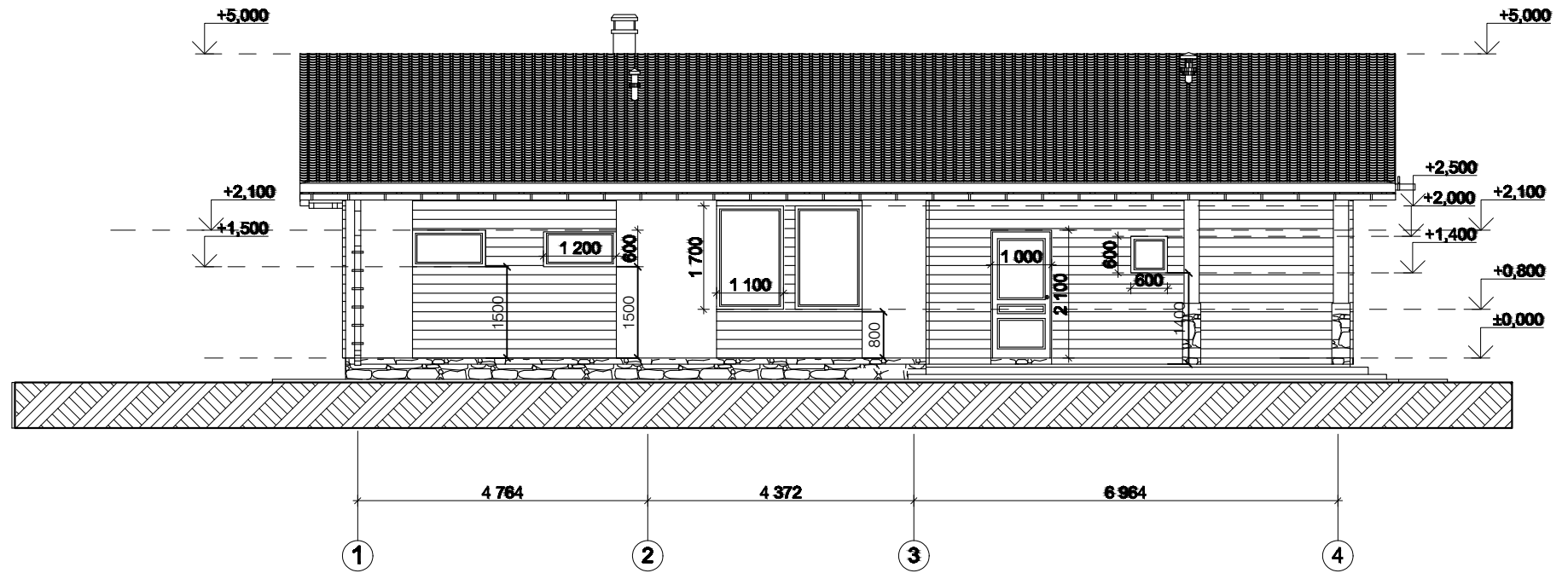

Фасад 4-1

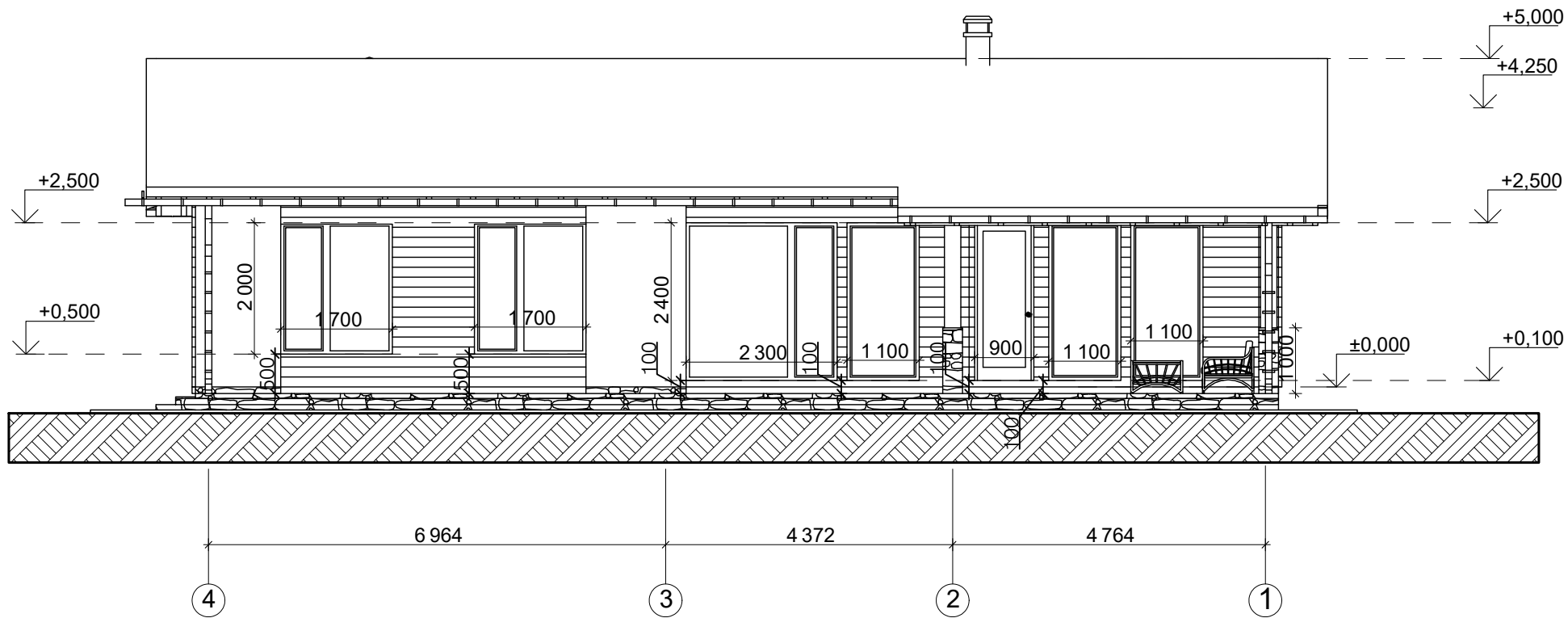

Фасад А-Е

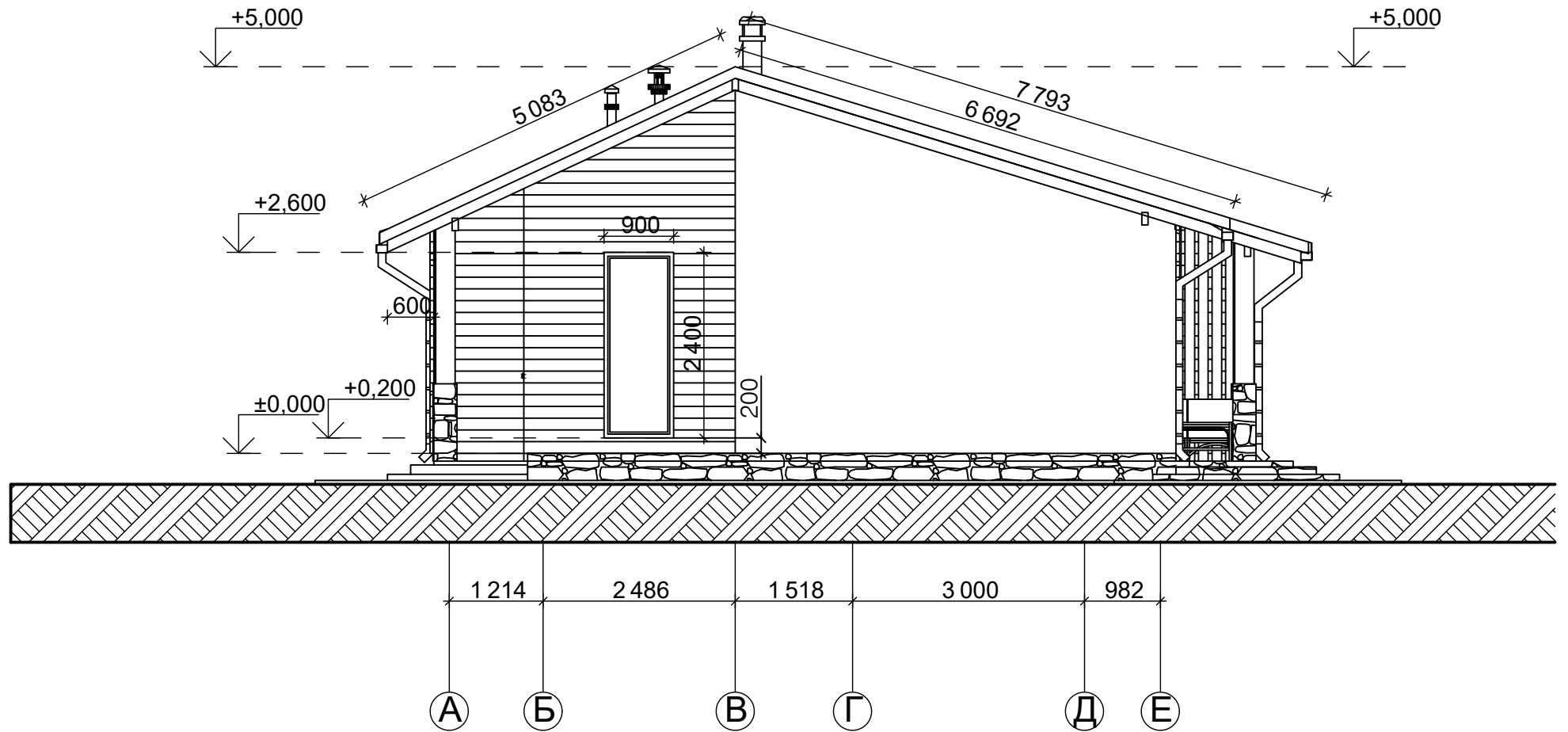

Фасад Е-А

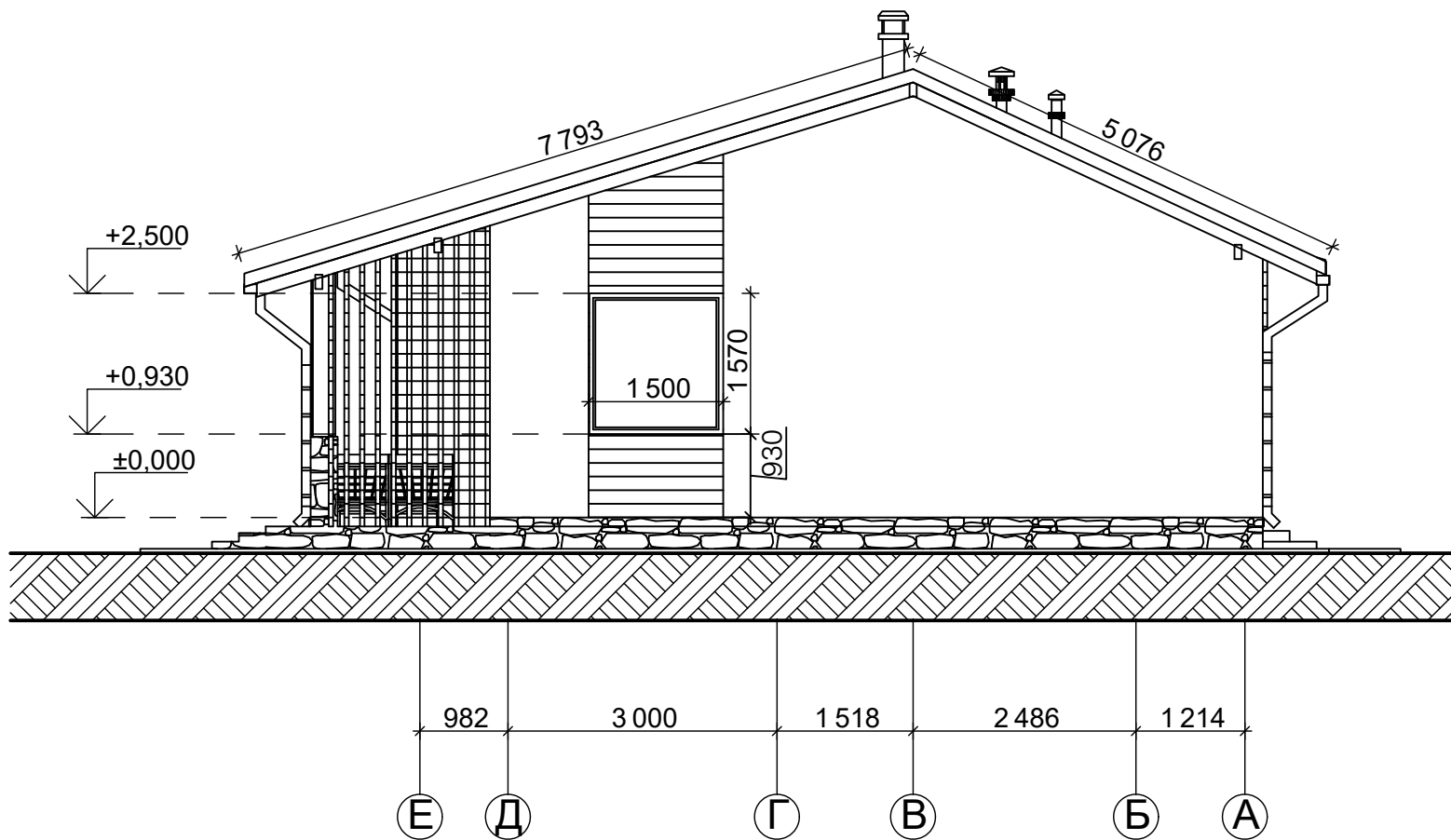

План кровли

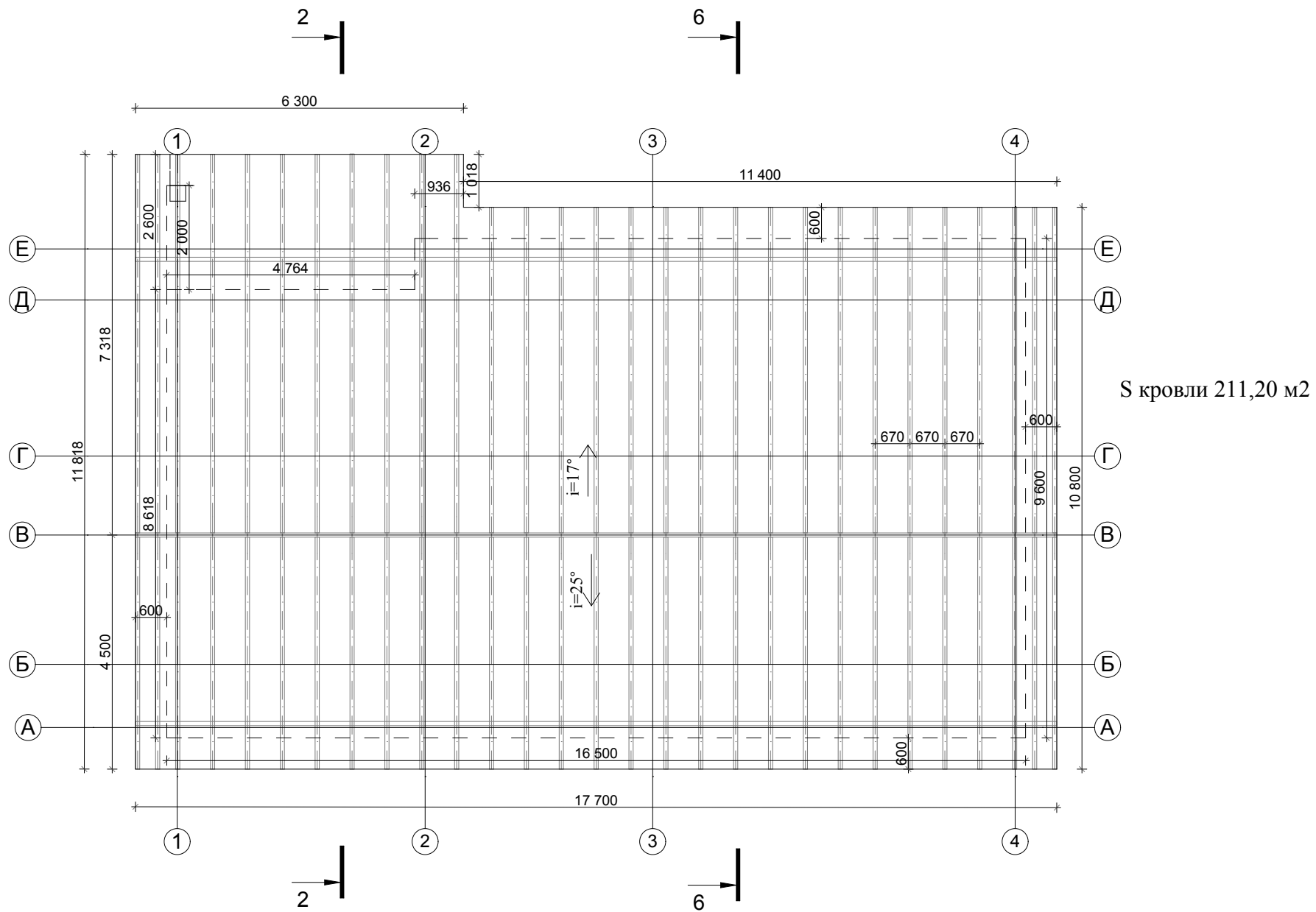

План осветительной сети

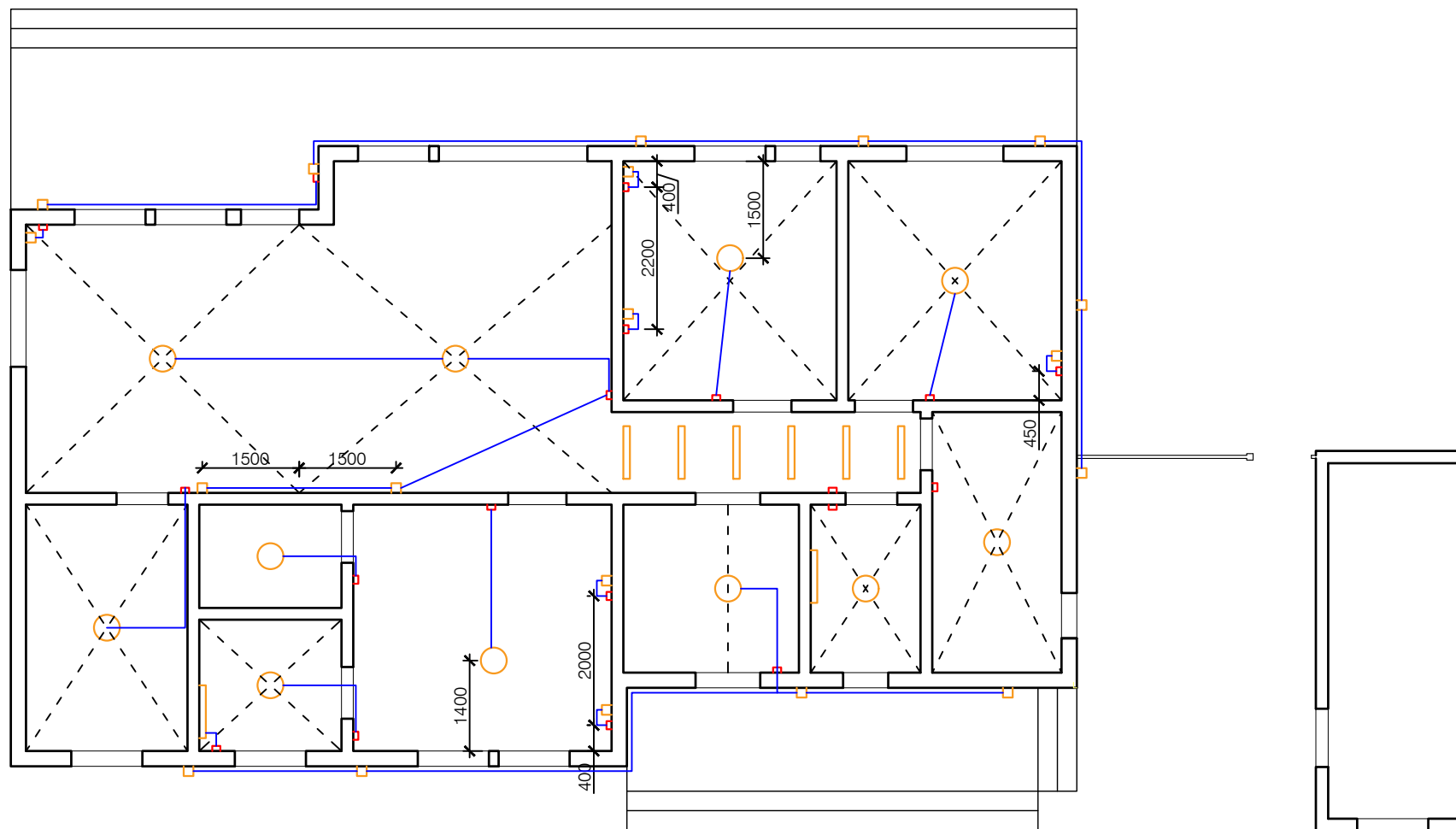

План розеточной сети

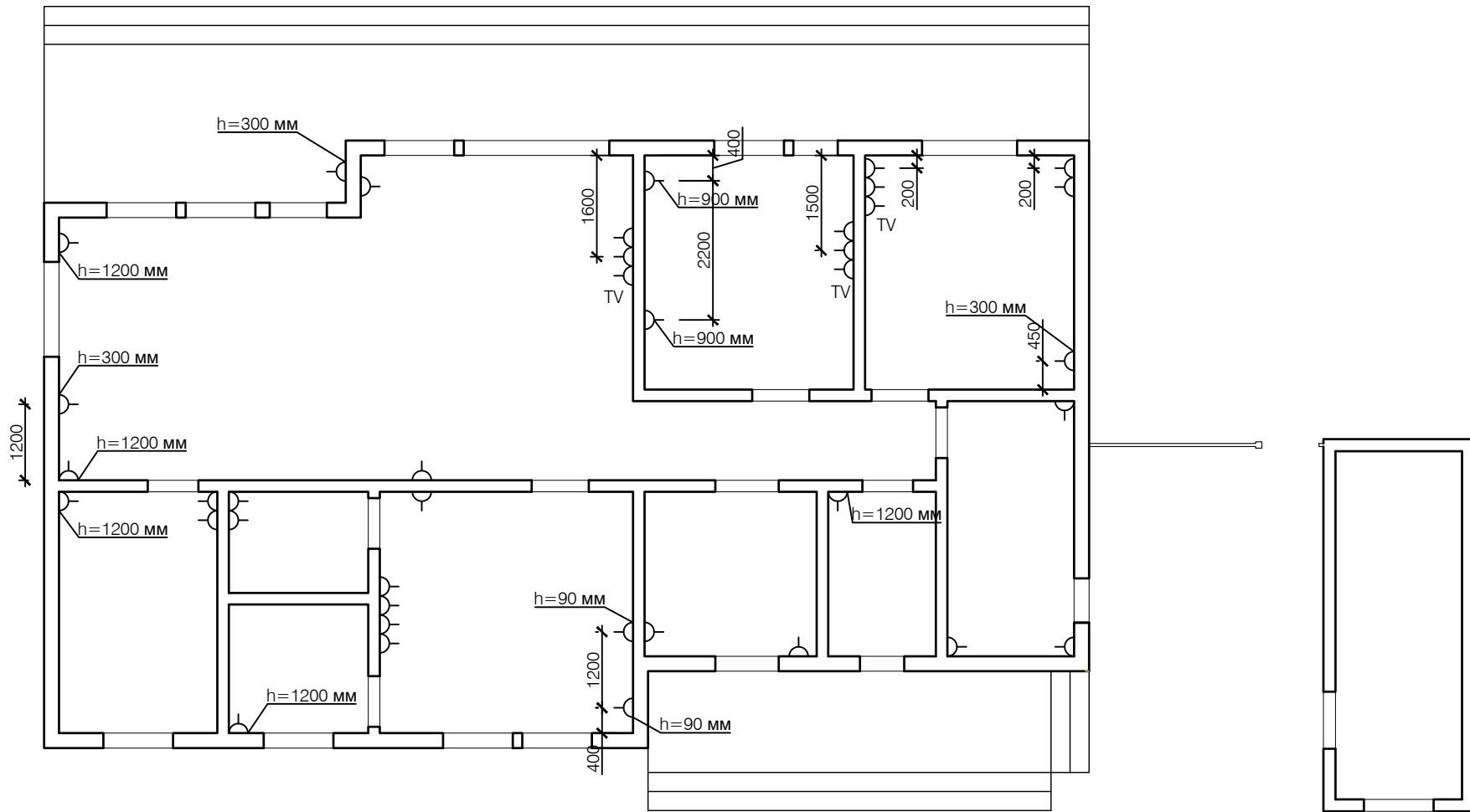

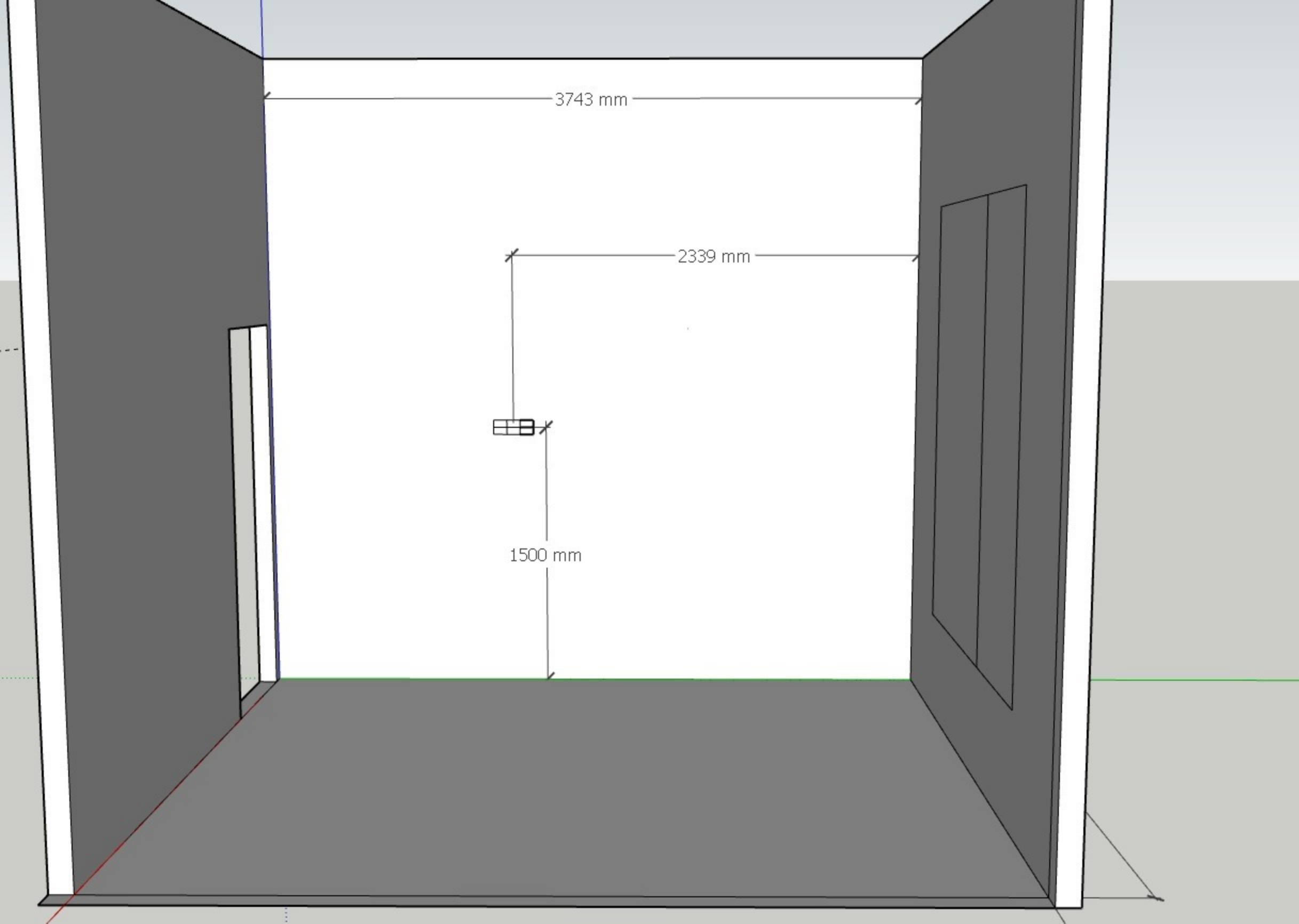

3743 mm

2339 mm

1500 mm

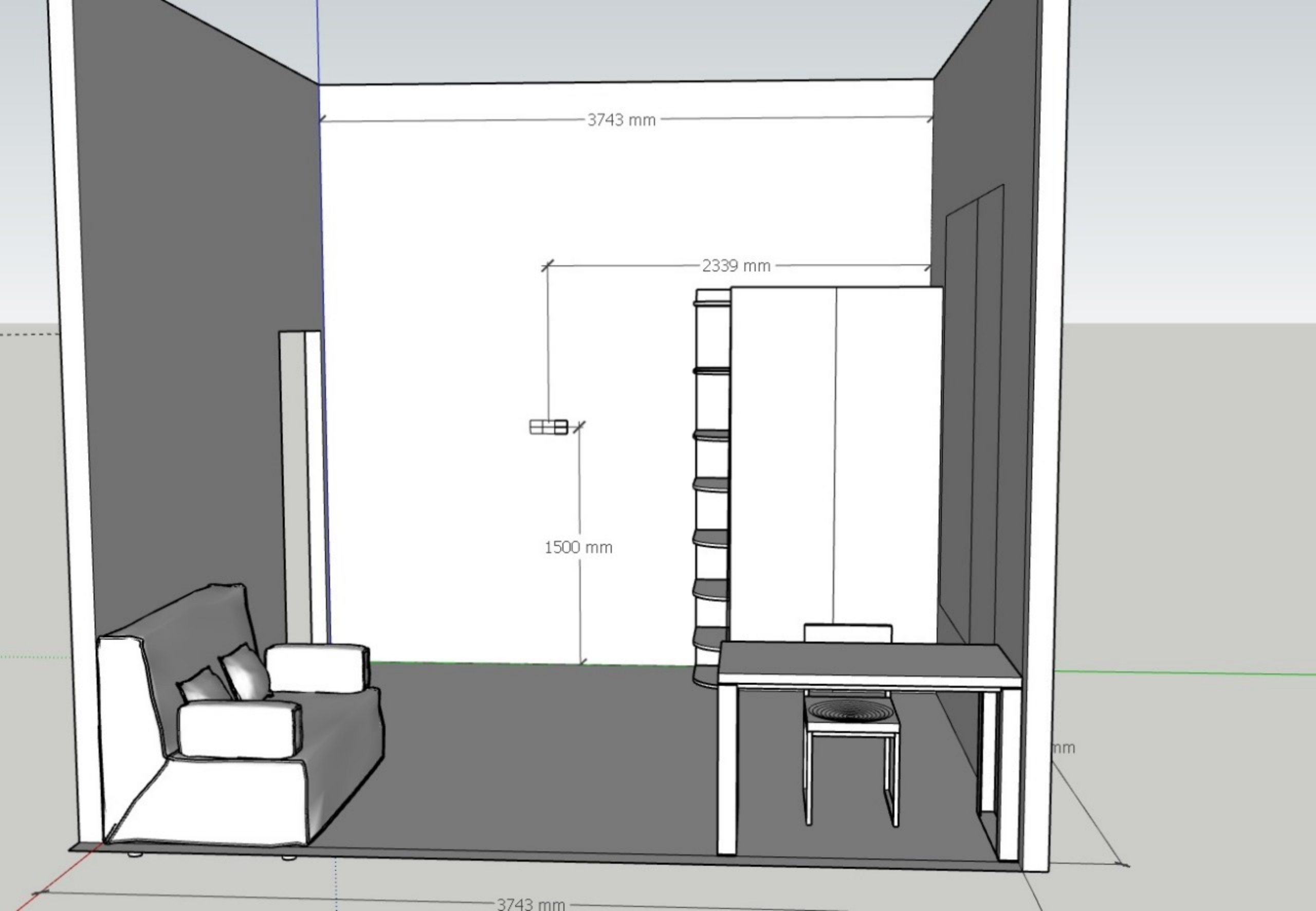

3743 mm

2339 mm

1500 mm



3743 mm

mm

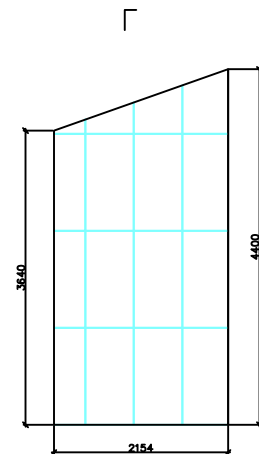
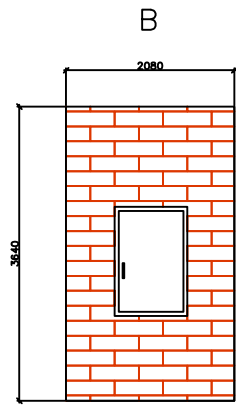
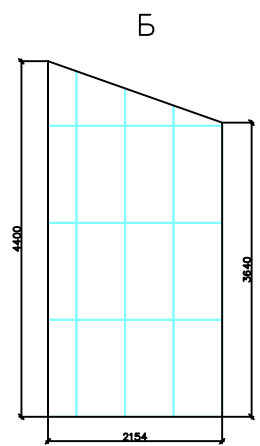
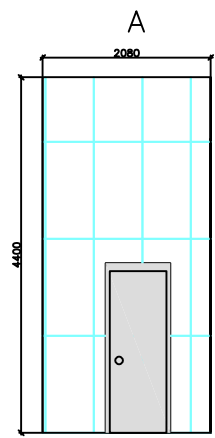
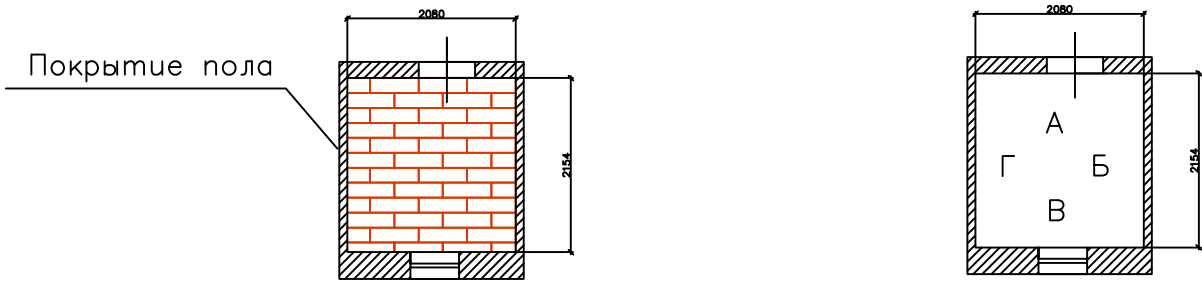
План раскладки плитки в ванной комнате



Условные обозначения:

-  — Раскладка $\frac{1}{2}$ керамогранитом Cersanit Yasmin темно-бежевый 60x18,5см
-  — Раскладка керамогранитом Delacora Oregon серый карбинг 120x60см

Изм.	Кол.уч.	Лист	Масштаб	Подпись	Дата		Страница	Лист	Листов
								1	
План раскладки плитки в ванной комнате							ООО "ССГ"		

Фасад 4-1

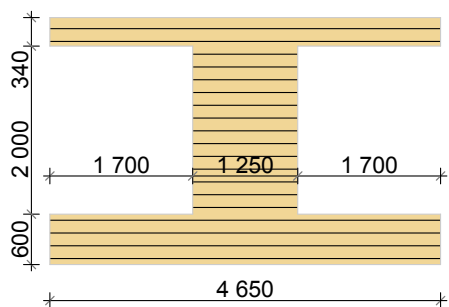

Планкен

- 19.75 м²

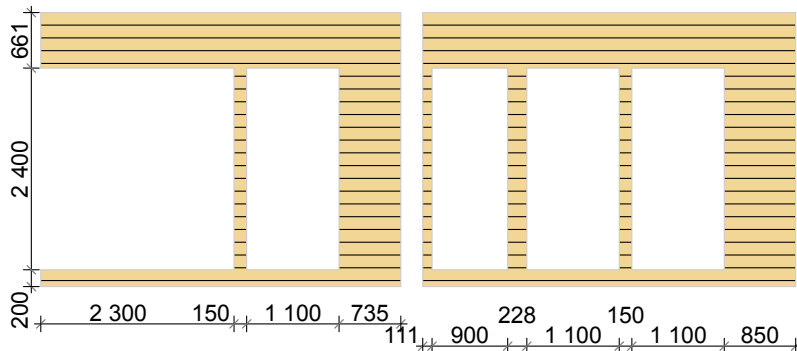

Фасад А-Е

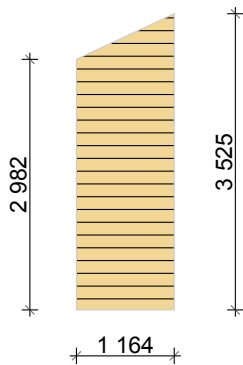

Планкен

- 3.80 м²

Фасад 1-4

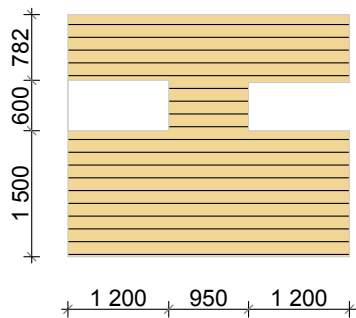

Планкен

- 34.55 м²

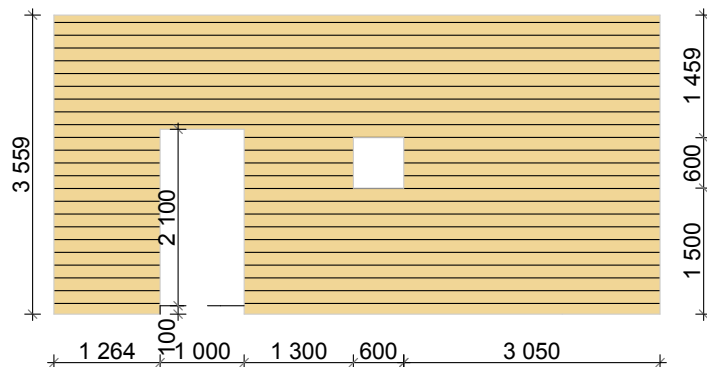
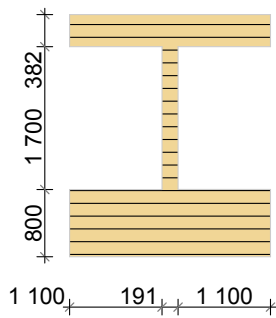

Фасад Е-А

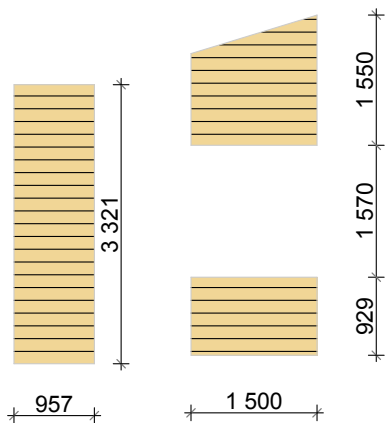

Планкен

- 6.55 м²

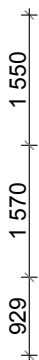



IZBURG



IZBURG

